

## H (m) TORRE - TOWER

380/440V 50/60 Hz	ARGANO WINCH	POTENZA MAX MAIN SUPPLY	GRUPPO GEN GEN UNIT
	15 HP	18 KVA	36 KVA
	25 HP	31 KVA	55 KVA

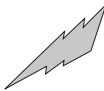

	F1	F	P
t	63	27	50

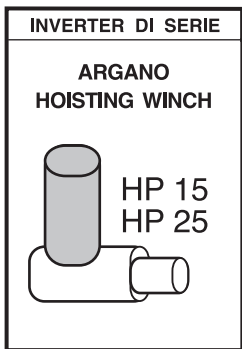
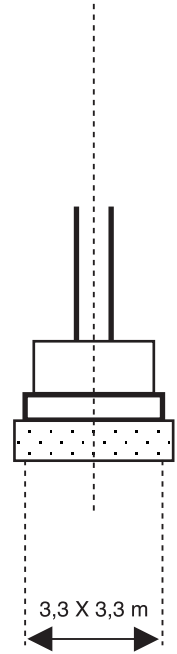
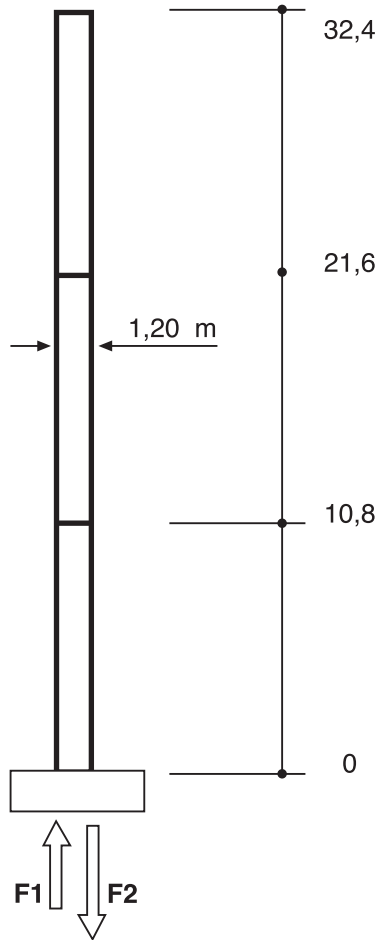
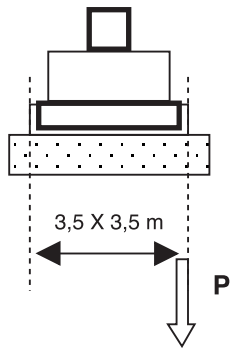

HP15 R 28		HP25 R 22	
m/min	t	m/min	t
45	1,25	70	1,25
22	2,5	35	2,5
3	2,5	5	2,5
22	2,5	35	2,5
11	5	17	5
1,5	5	2,5	5

I DATI NON SONO IMPEGNATIVI E POSSONO ESSERE MODIFICATI  
IN QUALSIASI MOMENTO

THE DATA CAN BE CHANGED IN EVERY MOMENT WITHOUT NOTICE

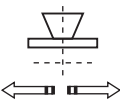
	RCO	0,8 rpm	65 Nm
	R 49	25/50 m/min	1,3/09 KW



**G.C. s.p.a.**

Via S. Gennariello, 26 - 80040 POLLENA TROCCHIA (NA) - ITALY  
Telefono 081 897 20 52 (PBX 3 linee) - Fax 081 530 22 92  
E-mail: gcgru@tin.it Internet: <http://www.gcitalia.com>

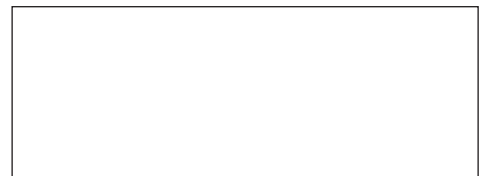

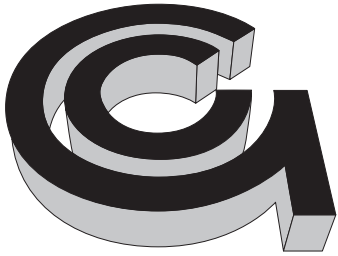

**SINCERT**



**G.C. s.p.a.**

**CITY 86**

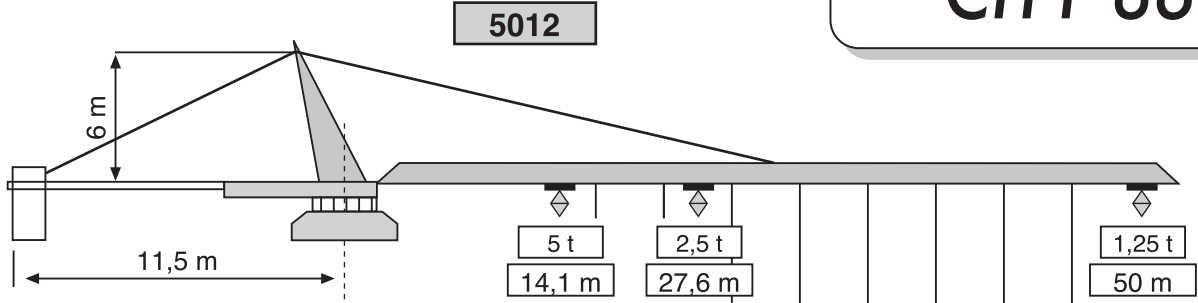

**5012**

t		2,5	2,3	1,9	1,8	1,5	1,4	1,25
m	5,0	4,0	2,2	2,0	1,7	1,5	1,2	1,1
m	14,1	17,1	27,6	30	34	37	43	44

**4515**

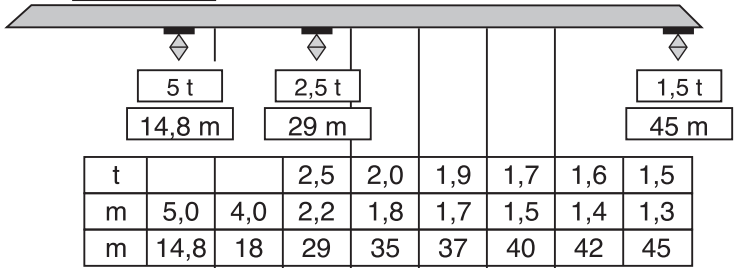

t		2,5	2,0	1,9	1,7	1,6	1,5
m	5,0	4,0	2,2	1,8	1,7	1,5	1,4
m	14,8	18	29	35	37	40	42

**3920**

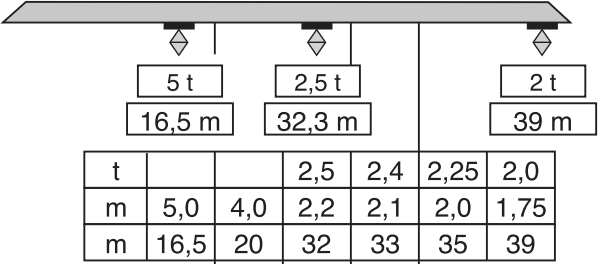

t		2,5	2,4	2,25	2,0
m	5,0	4,0	2,2	2,1	2,0
m	16,5	20	32	33	35

**3325**

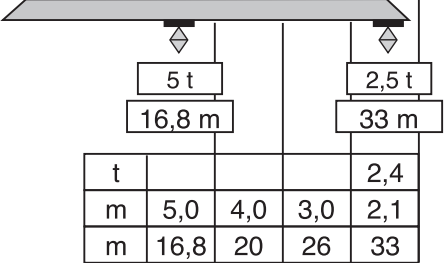

t			2,4
m	5,0	4,0	3,0
m	16,8	20	26

