

H (m) TORRE - TOWER

380/440 V 50/60 Hz	ARGANO WINCH	POTENZA MAX MAIN SUPPLY	GRUPPO GEN. GEN. UNIT
	25 HP	31 KVA	55 KVA

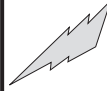
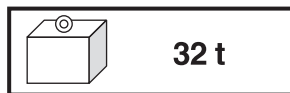

32 t

senza zavorra di volata

	F1	F2	P
t	79	93	45

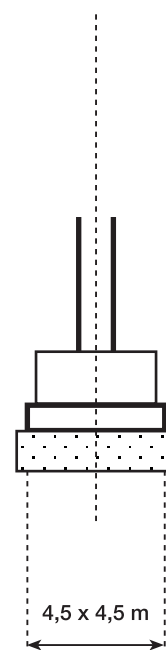
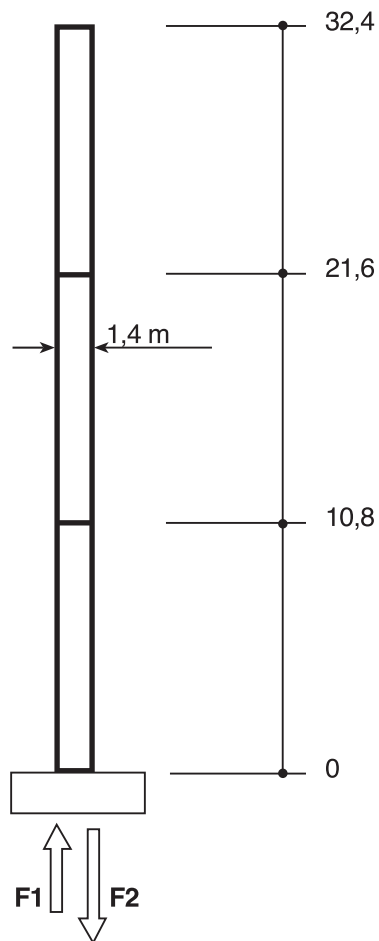
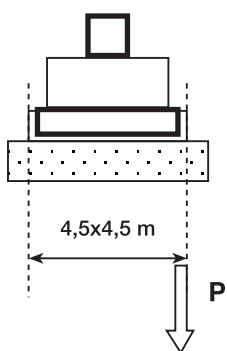

CONSULTARCI PER ALTEZZE SUPERIORI A QUELLE INDICATE

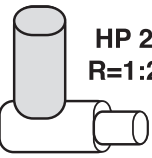
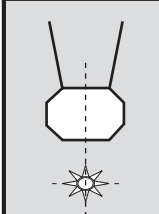
INVERTER DI SERIE	ARGANO HOISTING WINCH	TIRO II		TIRO IV	
		m/min	t	m/min	t
 HP 25 R=1:22		70	1,5	35	3
		35	3	17,5	6
		8	3	4	6

I DATI NON SONO IMPEGNATIVI E POSSONO ESSERE MODIFICATI IN QUALSIASI MOMENTO

THE DATA CAN BE CHANGED IN EVERY MOMENT WITHOUT NOTICE

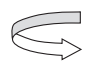
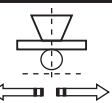
	RCO	0,8 rpm	2 x 65 Nm
	R 49	25/50 m/min	1,3/09 KW



G.C. s.p.a.

Via S. Gennariello, 26 - 80040 POLLENA TROCCHIA (NA) - ITALY
 Telefono 081 897 20 52 (PBX 3 linee) - Fax 081 530 22 92
 E-mail: info@gcitalia.com Internet: http://www.gcitalia.com



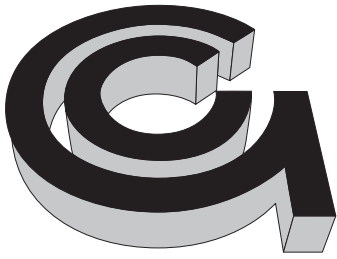

SINCERT



G.C. s.p.a.

CITY 100

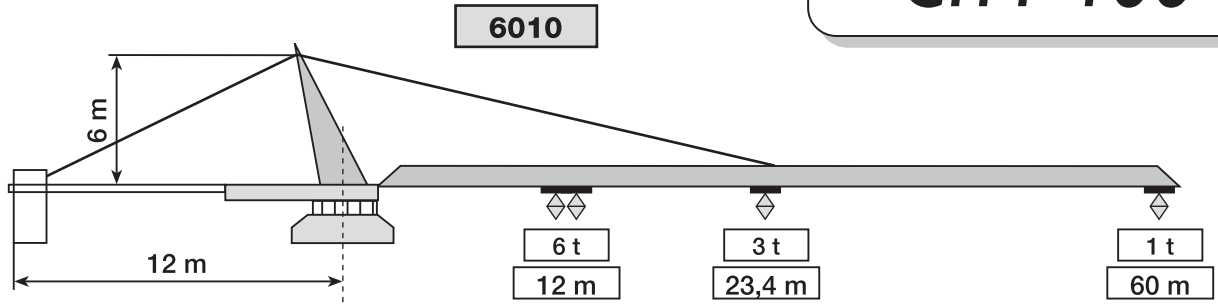

t										3,00	2,50	2,00	1,5	1,25	1,00
t	6,00	5,00	4,00	2,75	2,10	1,75	1,25	1,00	0,75						
m	12	14	17	23	28	34	43	50	60						

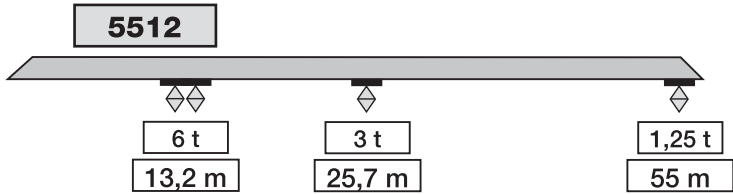

t										3,00	2,50	2,00	1,5	1,25
t	6,00	5,00	4,00	2,75	2,25	1,75	1,25	1,00						
m	13	16	19	26	30	37	47	55						

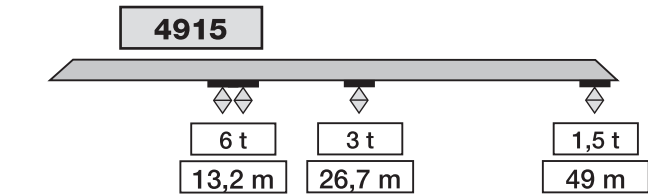

t										3,00	2,5	2,00	1,50
t	6,00	5,00	4,00	2,75	2,25	1,75	1,25						
m	14	16	19	27	31	38	49						

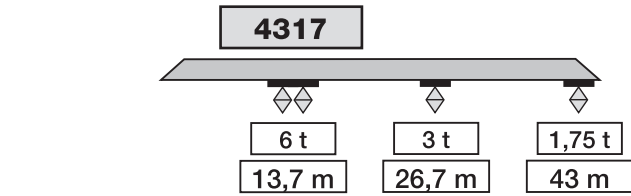

t										3,00	2,50	2,00	1,75
t	6,00	5,00	4,00	2,75	2,25	1,75	1,5						
m	14	16	19	27	31	38	43						

